



# **Instructions for Installation and Use**

## **Dual Fuel Cooker Model EG900X**

### **To the Installer**

Before installation fill in the product details on the back cover of this book.  
The information can be found on the rating plate.

### **To the User**

You must read the instructions prior to installing and using the appliance and  
then retain them for future reference.

# CONTENTS

Introduction	3
For Your Safety	4
Know your Cooker	5
How to use your Hob	6
How to use your Oven	7
Know your Timer	8
Cooking Advice	9
Cooking Chart	10
Care and Cleaning	11
Troubleshooting	12
Installation	13-14
Electrical Connection	15
Burner and Nozzle Specifications and Oven Specifications	16
After Sales Service	18
Hotpoint Guarantee	19
Key Contacts	Back Cover

## Retention of this Instruction Book

This Instruction Book must be kept handy for reference as it contains important details on the safe and proper use of the appliance.

If you sell or pass the appliance to someone else, or move house and leave it behind, make sure this Book is also provided so the new owner can become familiar with the appliance and safety warnings.

If the Book is lost or damaged a copy may be obtained from:  
Indesit Company LTD., Morley Way, Peterborough, PE2 9JB

# INTRODUCTION

Your new dual fuel cooker is guaranteed\* and will give lasting service. This guarantee is only applicable if the appliance has been installed in accordance with the installation instructions detailed in this booklet.

To help make best use of your cooking equipment, please read this booklet carefully.

The appliance is designed specifically for domestic use and responsibility will not be accepted for use in any other installation.

**Note: When the oven is first used, an odour may be omitted - this will cease after a short period of use.**

To help remove the 'new' smell, heat the empty oven to maximum temperature for a minimum of two to three hours, keeping the door closed. Ensure that the room is well ventilated (eg. open a window or use an extractor fan) and that persons who may be sensitive to the odour avoid any fumes. It is suggested that any pets be removed from the room until the smell has ceased.

This odour is due to any temporary finish on oven linings and any moisture absorbed by the insulation.

**\* The guarantee is subject to the provisions that the appliance:**

**(a) Has been used solely in accordance with this booklet.**

**(b) Has been properly connected to a suitable supply voltage as stated on the rating plate, attached to the appliance.**

**(c) Has not been subjected to misuse or accident or been modified or repaired by any person other than the manufacturers authorised employee or agent.**

**(d) Has been correctly installed.**

## IMPORTANT INFORMATION

- this appliance has been designed for private, non-professional domestic use in the home.
- read this instruction book carefully, as it provides important advice regarding safe installation, use and maintenance. Keep the instruction book in a safe place for future reference.
- the oven accessories that may come into contact with food are made of materials which comply with the provisions set forth by the EEC Directive 89/109 of 21/12/88 and the applicable national norms in force.
- after removing packaging, check that the appliance is intact. If in doubt, DO NOT use the appliance and contact a qualified serviceman.
- some parts are covered with a removable scratch-proof film. Before using the appliance, the film should be removed and the underlying part cleaned with a cloth and a non-abrasive household cleaning product.
- when switching the appliance on for the first time, we recommend you heat the oven on maximum temperature setting for about 30 minutes with nothing in it, to eliminate any residue from manufacture.
- all installation and adjustment operations should be carried out by a qualified serviceman in accordance with the applicable norms in force. Specific instructions are provided within the installation section of this instruction book.
- before connecting the appliance, make sure that the data on the rating plate (situated underneath the appliance) correspond to the mains electricity and gas supplies.
- check that the capacity of the electrical system and the power outlets are suitable for the maximum power of the appliance (indicated on the rating plate). If in doubt, consult a qualified technical engineer.
- check the condition of the gas pipe regularly and have it replaced by a qualified technical engineer as soon as it shows any signs of wear or anomaly.
- under no circumstances should the user replace the power supply cable of the gas connection pipe of this appliance. In the event of damage or the need for replacement, contact an authorised service centre only (see Key Contacts, back page).
- DO NOT leave the appliance plugged in if it is not in use. Switch off at the mains electrical switch and turn off the gas supply.
- During operation, the oven glass door and adjacent parts of the appliance become hot. Make sure, therefore, that children do not touch the appliance.

# FOR YOUR SAFETY

**When used properly your appliance is completely safe but as with any electrical product there are certain precautions that must be observed.**

**PLEASE READ THE BELOW PRECAUTIONS BEFORE USING YOUR APPLIANCE.**

To maintain the efficiency and safety of this appliance, we recommend you do the following:

- only call the Service Centres authorised by the manufacturer.
- always use genuine spare parts.

## **ALWAYS:**

- make sure you remove all packaging and dispose of safely.
- make sure you understand the controls before using the appliance.
- keep children away from the appliance during use.
- take care to avoid heat/steam burns when operating the controls.
- check the shelves are in the correct position before switching on the oven.
- make sure the controls are turned off when you have finished cooking and when not in use.
- ensure the door is closed when using the grill.
- disconnect from the power supply, and allow to cool, before cleaning or performing any maintenance.
- keep the door closed when the appliance is not in use.
- refer servicing to a qualified appliance service engineer.
- keep the appliance clean as a build up of grease or fat from cooking can cause a fire.
- follow the basic principles of food handling and hygiene to prevent the possibility of bacterial growth.
- keep any ventilation slots clear of obstructions.
- grip the handle in the centre when opening the door.
- stand back when opening the door to allow any build up of steam or heat to disperse.
- use dry, good quality oven gloves when removing items.
- dry food thoroughly before frying and lower it slowly into the hot oil or fat. Frozen food in particular, will cause frothing and spitting if added too quickly.
- keep outside of pans clean and free from streaks of oil or fat.
- place pans centrally over the cooking areas making sure handles are kept away from the edge of the hob and cannot be heated by other heating areas/pans.

## **NEVER:**

- use steam cleaners.
- attempt to install or repair the appliance without the assistance of qualified personnel.
- store items above the appliance that children may attempt to reach.
- heat up unopened food containers, as pressure can build up causing the container to burst.

## **SAFETY ADVICE**

**IMPORTANT** - As with any cooking appliance there could be some fire risk attached to the heating of oil, particularly for deep fat frying. Cooking utensils containing oil must not be left unattended (eg. to answer the telephone) on or in close proximity to the cooking areas.

### **IN THE EVENT OF A CHIP PAN OR ANY OTHER PAN FIRE:**

1. Turn off the burners.
2. Cover the pan with a fire blanket or damp cloth, this will smother the flames and extinguish the fire.
3. Leave the pan to cool for at least 60 minutes before moving it. Injuries are often caused by picking up a hot pan and rushing outside with it.

**NEVER USE A FIRE EXTINGUISHER TO PUT OUT A PAN FIRE** as the force of the extinguisher is likely to tip the pan over. Never use water to extinguish oil or fat fires.

- use the appliance to heat up anything other than food.
- use the appliance as a room heater.
- dry any items on the hob.
- install the appliance next to curtains or other soft furnishings.
- allow children to play with or tamper with the controls.
- leave children unsupervised where cooking appliances are installed as all the cooking surfaces get hot during and after use.
- store chemicals, foodstuffs or pressurised containers in or on the appliance, or in cabinets immediately above or next to the appliance.
- use plastic items on or near the appliance.
- use flammable liquids, such as alcohol or gasoline etc. near the appliance when it is in use.
- use adapters, multiple sockets and/or extension leads.
- fill a deep fat frying pan more than 1/3 full of oil, or use a lid on a deep fat frying pan. **DO NOT LEAVE UNATTENDED WHILE COOKING.**
- pull on the appliance or the supply cable to unplug it from the electrical outlet.
- allow power cables of other appliances to come into contact with hot parts of this appliance.
- expose the appliance to atmospheric agents, such as rain or sunlight.
- operate the appliance with wet hands.
- allow anyone to sit or stand on any part of the appliance.
- remove the oven shelves whilst the oven is hot.
- do not touch burners and cast iron pan supports remain hot for a long time.
- use the oven for storage purposes.
- use the grill to warm plates.
- dry items on the oven doors.
- fry too much food at a time, especially frozen food. This only lowers the temperature or the oil or fat too much, resulting in greasy food.
- use misshapen pans which may be unstable.
- use round base woks directly on the gas pan supports.
- use fish kettles or large preserving pans across two gas burners.
- operate the appliance when barefoot.

# KNOW YOUR COOKER

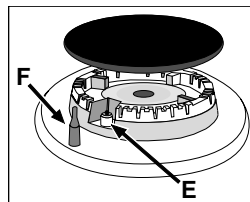
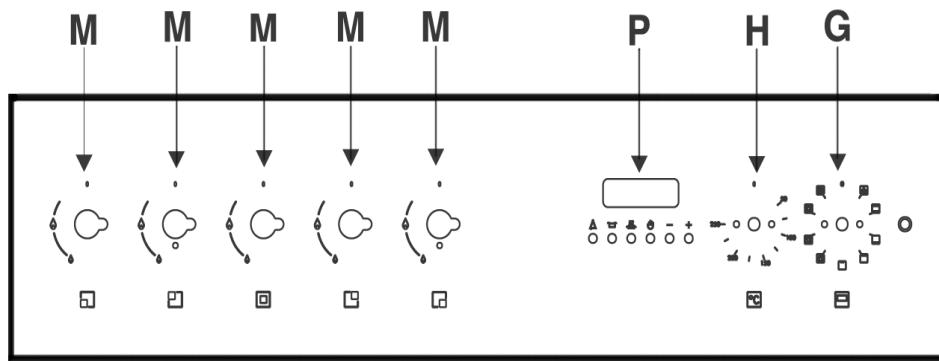

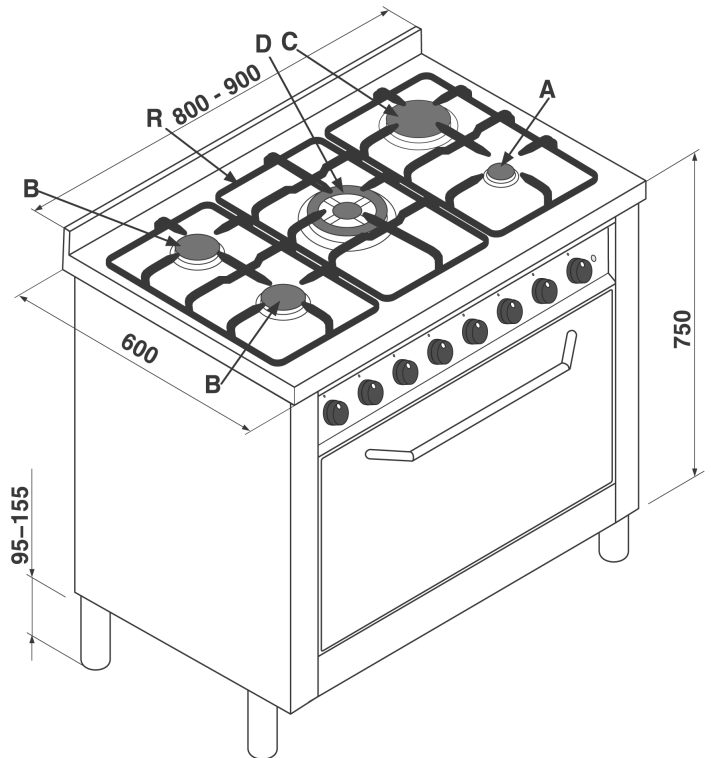

- A **Auxiliary gas burner**
- B **Semi-rapid gas burner**
- C **Rapid gas burner**
- D **Triple crown gas burner (wok burner)**
- E **Ignitor for gas burners**
- F **Flame Failue Device** - Activates if the flame accidentally goes out (spills, drafts, etc.), interrupting the supply of gas to the burner.
- G **Function Selector**
- H **Temperature Selector**
- M **Control knobs for gas burners**
- R **Pan support for cookware**
- P **Timer**



# HOW TO USE YOUR HOB

## Gas burners

On the control panel, the following symbols are indicated around each knob "M".

- Off 
- High flame 
- Low flame 

The symbols  near the knobs indicate the position of each burner on the hob.

The burners are fitted with a flame failure device. This device interrupts the gas supply should the burner flame go out during operation.

To **light one of the burners**, proceed as follows:

- turn the appropriate control knob anti-clockwise until the pointer is on the high-flame symbol.
- press the knob down fully to activate the automatic gas ignition.
- keep the knob pressed down for about 6 seconds with the flame lit to allow the flame failure device to heat.
- release the knob, checking that the flame is stable. If it is not, repeat the operation.

For minimum power, turn the knob towards the low flame symbol. Intermediate positions are possible by simply setting the knob anywhere between the high and the low flame symbol.

## Important:

- Do not activate the automatic ignition device for more than 15 consecutive seconds.
- Difficulty in ignition is sometimes due to air inside the gas duct.
- If a burner flame accidentally goes out, the gas continues to exit for a few moments before the flame failure device is activated. Turn the control knob to the off position and do not attempt ignition again for at least 1 minute, thereby letting the gas disperse, which could otherwise be a danger.
- When the appliance is not in operation, check that all control knobs are set to the off position " ● ". The main gas supply tap should also be turned off.

## Practical advice on using the hob:

To obtain maximum efficiency from the burners, we recommend you only use pans with a diameter suitable for the burner being used, so that the flame does not extend beyond the pan base (see the following table).

When a liquid starts boiling, we recommend you turn the flame down just enough to keep the liquid simmering.

BURNER	∅ Pan Diameter (cm)
A. Auxiliary	6 - 14
B. Semi-rapid	15 - 20
C. Rapid	21 - 26
D. Triple ring	24 - 26

The hob is fitted with a reducing pan stand (shown right) which should only be used on the auxiliary burner 'A'.



For the best performance of your burners, keep the following in mind:

All types of pans can be used on the burners. The important thing is that the bottom should be completely flat.



# HOW TO USE YOUR OVEN

The **'Multi-function'** oven combines the advantages of convection ovens with those of fan assisted models in a single appliance. It is an extremely versatile appliance that allows you to choose easily between 7 different cooking modes. The various cooking modes are selected by means of the function selector 'G' and the temperature selector 'H' situated on the control panel:

## Oven light

By turning the function selector to  the interior light is switched on and allows you to observe the food in the oven without having to open the door. The oven light will come on automatically when the function selector 'G' is turned to any of the cooking modes.

**Warning:** Never place anything on the bottom of the oven when it is in operation because this could damage the enamel. Always place your cookware (dishes, aluminium foil, etc.) on the shelves provided with the appliance inserted along the oven shelf guides.

## The Cooking Modes:

### Convection

Position the temperature selector "H" between **50°C** and **250°C**.

The top and bottom heating elements are used. The heat is distributed evenly from the top to the bottom. The convection oven is best for preparing meat-based dishes featuring beef or veal which require slow cook and basting. It is the best cooking mode for dry pastries and fruit in general. When cooking in convection mode, only use one baking tray or shelf at a time, otherwise the heat distribution will be uneven. Select from among the various shelf positions based on whether the dish needs more or less heat from the top.

### Bottom heating element

Position the temperature control "H": between **50°C** and **250°C**.

By turning the function selector to this position, the bottom heating element comes on. This is recommended for finishing off the cooking of food (in baking trays) which is well cooked on the surface but still soft inside.

### Minigrill heating element

**Important:** do not set the temperature selector 'H' over **200°C**.

By turning the function selector to this position, the upper heating element comes on. This is recommended for finishing off the cooking of food (in baking trays) which is already well cooked inside but needs browning.

### Grill

**Important:** do not set the temperature selector 'H' over **200°C**.

Food is cooked in the grill by the downward thermal rays produced by an incandescent electric cooking element. **The extremely high and direct temperature of the grill makes it possible to brown the surface of meats and roasts while locking in the juices to keep them tender. The grill is also highly recommended for dishes that require a high surface temperature: such as beef steaks, veal, fillet steaks, hamburgers etc...**

**Important:** when grilling, the oven door must be kept shut.

### Fanned Grill

**Important:** do not set the temperature selector 'H' over **175°C**.

The heating element of the grill is activated, as well as the fan. This combination of features increases the effectiveness of the thermal radiation of the heating elements through forced air circulation throughout the oven. This helps to prevent foods from burning on the surface, allowing the heat to penetrate into the food.

**Important:** when grilling, the oven door must be kept shut.

### Fan assisted Mode

Position the temperature control "H": between **50°C** and **250°C**.

Both the heating elements and the fan, will come on. Since the heat remains constant and uniform throughout the oven, the air cooks and browns food uniformly over its entire surface. With this mode, you can also cook various dishes at the same time, as long as their respective cooking temperatures are the same. A maximum of 2 shelves can be used at the same time, following the instructions in the section entitled: "Cooking On More Than One Shelf". This fan assisted mode is particularly recommended for dishes requiring a gratin finish or for those requiring considerably prolonged cooking times, such as for example: lasagne, pasta bakes, roast chicken and potatoes, etc... Moreover, the excellent heat distribution makes it possible to use lower temperatures when cooking roasts. This results in less loss of juices, meat which is more tender and a decrease in the loss of weight for the roast. This mode is especially suited for cooking fish, which can be prepared with the addition of a limited amount of condiment, thus maintaining their flavour and appearance.











### Baking

Position the temperature control "H": between **50°C** and **250°C**.

The rear heating element and the fan come on, guaranteeing delicate heat distributed uniformly throughout the oven. This mode is ideal for baking and cooking delicate foods- especially cakes that need to rise. Cooking is also possible on both shelves. The oven heats up very quickly, so the food to be cooked may be put in the oven as it is switched on.

### Fast defrosting

This function uses no heating elements, just the fan.





Symbol	Function	Power
	0) Off	-
	1) Oven Light	50 W
	2) Top + Bottom heating elements	2350 W
	3) Bottom heating element	1300 W
	4) Minigrill heating element	1050 W
	5) Grill heating element	2000 W
	6) Grill heating element + fan	2050 W
	7) Top + Bottom heating element + fan	2400 W
	8) Rear round heating element + fan	2850 W
	9) Fast defrosting	50 W

## TIMER (ELECTRIC OVEN)

The programmer makes it possible to preset the oven and the grill in terms of:



- delay start with a preset length of time for cooking;
- immediate start with a preset length of time for cooking;
- timer.

Button functions:

-  : Timer with hour and minutes
-  : Length of cooking time
-  : End cooking time
-  : Manual change
- : Change time (backwards)
- + : Change time (forwards)

### How to Reset the Digital Clock

After the appliance has been connected to the power source or following a power outage, the clock display will begin to blink and read: **0:00**

- Press the  and  buttons at the same time. Then use (within 4 seconds) the - and + buttons to set the exact time.

Use the + button to move the time forwards.

Use the - button to move the time backwards.

The time can also be changed in the following two ways:

1. Repeat all of the foregoing steps.
2. Press the  button, and then use the - and + buttons to reset the time.

### Manual Operation Mode for the Oven

After the time has been set, the programmer is automatically set to manual mode.

**Note:** Press the  button to return the oven to manual mode after every "Automatic" cooking session.

### Delayed Start Time with Preset Cooking Length

The length and the end cooking times must be set.

Let us suppose that the display shows 10:00

1. Turn the oven control knob to the cooking setting and temperature desired (example: convection oven at 200°C).
2. Press the  and use (within 4 seconds) the - and + buttons to set the length of the cooking time. Let us suppose that 30 minutes was set for the length of the cooking time. In this case, the display will show:

  0:30

Release the button, and within 4 seconds, the current time will reappear with the  symbol and "auto."



3. Press the  button, and then use the - and + buttons to set the end cooking time. Let us suppose that it is 1pm

 13:00

4. Release the button and the display will show the current time within 4 seconds:

 10:00

When "auto" is illuminated, it indicates that the length and end cooking time have been preset to operate in automatic mode. At this point, the oven will turn on automatically at 12:30 in order to finish the cooking session within 30

minutes. When the oven is on, the  symbol (cooking pot) will appear on the display for the entire length of the cooking process. The  button can be pressed at any time to display the setting for the length of the cooking time, while the  button can be pressed to display the end cooking time.

**At the end of the cooking time, an acoustic signal will sound. Press any button it turn it off (except the - and + buttons).**

### Immediate Start Time with Preset Cooking Length

When only the length of the cooking time is set (points 1 and 2 of the paragraph entitled, "Delayed Start Time with Preset Cooking Length"), the cooking session starts immediately.

### Cancelling a Preset Cooking Time

Press the  button, and use the - button to set the time to:

0:00

Then press the manual cooking mode button .

### Timer Feature

The timer can be used to count down from a given length of time. This feature does not control when the oven comes on or turns off, but, rather, it only emits an alarm when the preset time has expired.

Press the  button, and the display will read:

0:00

Then use the - and + buttons to set the desired time. Release the button, and the timer will start at that second. The display will show the current time.

10:00

At the end of the preset time, an alarm will sound, which can be turned off by pressing any button (except the - and + buttons), and the  symbol will turn off.

### Changing and Cancelling Settings

- The settings can be changed at any time by pressing the corresponding button and using the - or + button.
- When the length setting for the cooking time is cancelled, the end cooking time setting is also cancelled, and vice versa.
- When in automatic cooking mode, the appliance will not accept end cooking times prior to the start cooking time proposed by the appliance itself.

## COOKING ADVICE

The oven offers a wide range of alternatives which allows you to cook any type of food in the best possible way. With time you will learn to make the best use of this versatile cooking appliance and the following are only a guide, which may be varied according to your own personal taste.

### Preheating

If the food being cooked needs to go into a preheated oven (this is generally the case when cooking leavened foods) the 'fan assisted' mode  can be used to reach the desired temperature as quickly as possible. When preheating is over, place food in the oven and select the most appropriate cooking mode.

### Cooking on More Than One Shelf

If you want to cook on more than one shelf at a time, use the "fan assisted" mode .

When cooking food on several shelves keep the following suggestions in mind:

- The oven is fitted with 5 shelf positions. During fan assisted cooking, use two of the three central shelf positions; the lowest and highest shelves receive the hot air directly and therefore delicate foodstuffs could be burnt on these shelf positions.
- As a general rule, use the 2nd and 4th shelf position from the bottom, placing the foodstuffs that require greater heat on the 2nd shelf position from the bottom. For example, when cooking meat roasts together with other food, place the roast on the 2nd shelf position from the bottom and the more delicate food on the 4th shelf position from the bottom.
- When cooking food that require differing times and temperatures, set a temperature that is somewhere between the two temperatures required, place the more delicate food on the 4th shelf position from the bottom and take the food requiring less time out of the oven first.
- Use the baking tray on the lower shelf position and the shelf on the upper position.

### Baking Cakes



When baking cakes, always preheat the oven. Make sure you wait until the oven has preheated thoroughly. Do not open the oven door during baking to prevent the cake from dropping. In general, if:

<b>Cake too dry</b>
The next time, set a temperature which is greater by 10°C and reduce the cooking time.a.
<b>Cake flattens</b>
Use less liquid or lower the temperature by 10°C.
<b>Cake blackens on top</b>
Insert it a lower height, set a lower temperature and lengthen the cooking time.
<b>Well cooked on the outside but gluey inside</b>
Use less liquid, reduce the temperature and increase the cooking time.
<b>The cake is stuck to the baking tin</b>
Grease the baking tin well and sprinkle it with a dusting of flour or use greaseproof paper.

**I used more than one rack (in the "fan-assisted" mode) and they are not all at the same stage of cooking**

Use a lower temperature setting. It is not necessary to remove the food from all the racks at the same time.

### Using the Grill

The Grill setting  grills traditional foods perfectly (such as toasted sandwiches, hotdogs etc.). The Fanned Grill setting  is extremely useful for grilling foods rapidly, as the distribution of heat makes it possible not only to brown the surface but also to cook the bottom part. This mode can also be used for browning foods at the end of the cooking process.

**Important: always use the grill with the oven door closed.**

This will allow you both to attain excellent results and to save energy (approximately 10%). For best results when using the grill, it is recommended to use the highest temperature (200°C) (175°C for fanned grilling), the grill pan should be placed on the higher shelf.

### Cooking Fish and Meat

Meat must weigh at least 1kg to prevent it from drying out. When cooking white meat, fowl and fish, use temperature settings from 150 °C to 200 °C. For red meat that should be well done on the outside while tender and juicy in the inside, it is a good idea to start with a high temperature setting (200°C-220°C) for a short time, then turn the oven down afterwards. In general, the larger the roast, the lower the temperature setting. Place the meat on the centre of the shelf and place the grill pan/baking tray beneath it to catch the fat. Make sure that the shelf is inserted so that it is in the centre of the oven. If you would like to increase the amount of heat from below, use the low shelf positions.

### Cooking Pizza

For best results when cooking pizza, use the "fan assisted" mode:

- Preheat the oven for at least 10 minutes.
- Use a light aluminium pizza pan, placing it on the shelf supplied with the oven. If the baking tray is used, this will extend the cooking time, making it difficult to get a crispy crust.
- Do not open the oven door frequently while the pizza is cooking.
- If the pizza has a lot of toppings (three or four), we recommend you add the mozzarella cheese on top halfway through the cooking process.

### Cooling ventilation

In order to cool down the exterior of the appliance, it is fitted with a cooling fan that comes on when the function selector "G" is turned. In this case, the fan is always on and a normal flow of air can be heard exiting between the oven door and the control panel.

**Note: when cooking is finished, the fan stays on until the oven has cooled down sufficiently, even if the function selector "G" is set to "0".**

Once you have removed the food from the oven, we recommend you leave the oven door ajar for a few minutes, this will drastically reduce the duration of the cooling cycle. The process is controlled by an additional thermostat and can consist of one or more cycles.

# COOKING CHART

NB. Cooking times shown in the charts are approximate and may vary according to personal taste. When cooking a certain food for the first time, it is advisable to choose the lowest values in the cooking time range given in the table and then increase times if necessary.

## CONVENTIONAL oven cooking

Type of dish	Temperature °C	Cooking time (minutes)	Type of dish	Temperature °C	Cooking time (hours)
<b>Pastries and cakes</b>			<b>Meat</b>		
Fruit Pie	130	60-70	Turkey (4-8kg)	160	3 - 4 1/2
Meringues	130	30-40	Goose (4-5kg)	160	4 - 4 1/2
Sponge Cake	150	20-30	Duck (2-4kg)	170	1 1/2 - 2 1/2
Angel Cake	160	40-50	Capon (2 1/2- 3 kg)	170	2 - 2 1/2
Madeira Cake	160	40-50	Braised Beef	160	3 - 3 1/2
Chocolate Cake	170	30-40	Leg of Lamb	160	1 - 1 1/2
Flat Sweet Loaf	170	40-50	Roast Hare	160	1 - 1 1/2
Puffs	200	15-20	Roast Pheasant	160	1 - 1 1/2
Flaky Pastry Biscuits	200	15-20	Chicken	170	1 - 1 1/2
Mille Feuilles	200	15-20			
Short Crust Pastry	200	15-20	<b>Fish</b>	200	15-25 minutes

## GRILLING

Type of dish	Cooking time (minutes)	Position on shelf	
Chops (0.5 kg)	60	3rd guide rail	The 1st guide rail is understood as being the lowest position.
Sausages	15	2nd guide rail	
Grilled Chicken (1 kg)	60	1st guide rail	

## FAN ASSISTED cooking

Type of dish	Guide rail no. from bottom	Quantity kg	Temperature °C	Cooking time (minutes)
<b>Cakes</b>				
*With beaten mix, in tin	1 - 3	1	175	60
*With beaten mix, without tin	1 - 3 - 4	1	175	50
Short pastry, flan base	1 - 3 - 4	0.5	175	30
Short pastry with wet filling	1 - 3	1.5	175	70
Short pastry with dry filling	1 - 3 - 4	1	175	45
*With natural leavened mix	1 - 3	1	175	50
Small cakes	1 - 3 - 4	0.5	160	30
<b>Meat</b>				
<b>Roasts under the grill</b>				
Veal	2	1	180	60
Beef	2	1	180	70
English Roast Beef	2	1	220	50
Pork	2	1	180	70
Chicken	2	1 - 1.5	200	70
<b>Roasts on a tray</b>				
Veal	1 - 3	1	160	80
Beef	1 - 3	1	160	90
Pork	1 - 3	1	160	90
Chicken	1 - 3	1 - 1.5	180	90
Turkey slices	1 - 3	1.5	180	120
Duck	1 - 3	1 - 1.5	180	120
<b>Casseroles</b>				
Beef casserole	1	1	175	120
Veal casserole	1	1	175	110
<b>Fish</b>				
Fillets, steaks, cod, hake, sole	1 - 3	1	180	30
Mackerel, turbot, salmon	1 - 3	1	180	45
Oyster	1 - 3		180	20
<b>Miscellaneous</b>				
Baked pasta dish	1 - 3	2	185	60
Vegetable pudding	1 - 3	2	185	50
*Sweet and savoury souffles	1 - 3	0.75	180	50
*Pizzas and savoury rolls	1 - 3 - 4	0.5	200	30
Toasted sandwiches	1 - 3 - 4	0.5	190	15
<b>Defrosting</b>				
Ready to eat meals	1 - 3	1	200	45
Meat	1 - 3	0.5	50	50
Meat	1 - 3	0.75	50	70
Meat	1 - 3	1	50	110

### Notes.

- 1) Cooking times do not include oven preheating, except for those marked with an asterisk.
- 2) The indication given in the table for the guide rails is the one that should preferably be used in the event of cooking on more than one level.
- 3) The indicated times refer to cooking on one shelf only, for cooking on more than one shelf increase the time by 5 - 10 minutes.
- 4) For roast beef, veal, pork and turkey, on the bone or rolled, increase the times by 20 minutes.

## CARE AND CLEANING

Before cleaning or carrying out any maintenance on your appliance, you must disconnect it from the power supply.

**To extend the life of your appliance, it must be cleaned frequently, keeping in mind that:**

### The hob:

- The enamelled parts must be washed with warm water without using any abrasive powders or corrosive substances which could cause damage.
- The removeable parts of the burners should be washed with warm soapy water making sure to remove caked on substances.
- The end of the electronic ignition device must be cleaned carefully and frequently, making sure that the gas holes are not clogged.
- Stainless steel may become marked if it comes into contact with very hard water or harsh detergents (containing phosphorous) for long periods of time. After cleaning, rinse with water and dry thoroughly. Use a specific non-abrasive product to remove tougher stains. It is also recommended that any spills be cleared immediately.

### Inside the oven

We recommend you clean your oven each time you use it, especially after cooking roasts. In fact, it is advisable to prevent food residue from building up during cooking: the residue would be re-cooked each time the oven is used and would char and release smoke and unpleasant odours.

### Oven exterior

Clean the stainless steel exterior surfaces of your oven using a sponge soaked in soapy water, making sure you rinse and dry these thoroughly, without using abrasive or corrosive products which could damage them.

**DO NOT use aluminium foil to line the bottom of the oven.**

To avoid having to clean the bottom of the oven, you may be tempted to line it with some aluminium foil. We strongly advise against this. The aluminium foil sheet in direct contact with the heated enamel coating could melt and damage the enamel coating inside the oven irreversibly.

### Oven rubber Seal

There is a rubber seal surrounding the oven opening which guarantees its perfect functioning. Check the condition of this seal on a regular basis. If necessary, clean it using warm water and dry thoroughly.

DO NOT use abrasive products or objects to do so.

Should the seal become damaged, please contact Hotpoint Service (see KEY CONTACTS, back page). We recommend you avoid using the oven until it has been repaired.

### Replacing the Oven Lamp

- Disconnect from the mains electricity supply and ensure the appliance is cool.
- Remove the glass cover of the lamp-holder.
- Remove the lamp and replace with a lamp resistant to high temperatures (300°C) with the following characteristics:

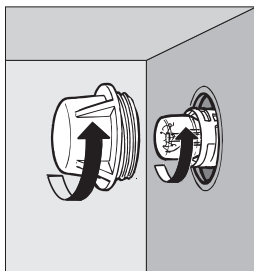

- Voltage: 230/240 V
  - Power: 15W
  - Type E14
- Replace the glass cover and reconnect to the mains electricity supply.

### Disassembling/assembling the oven door

To make it easier to clean the inside of your oven, the oven door can be removed, by proceeding as follows (fig. 3-4):

- Open the door completely and raise the 2 levers "B" (fig. 3);
- Now, shutting the door slightly, you can lift it out by pulling out the hooks "A" as shown in figure 4.

To **reassemble** the door:

- With the door in a vertical position, insert the two hooks "A" into the slots;
- Ensure that seat "D" is hooked perfectly onto the edge of the slot (move the oven door backwards and forward slightly);
- Keep the oven door open fully, unhook the 2 levers "B" downwards and then shut the door again.

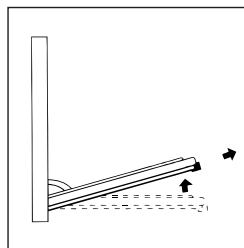

fig 4

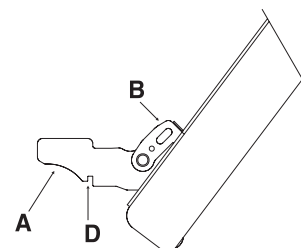

fig 3

# Troubleshooting

Before calling service for assistance, check through the following list, there may be nothing wrong.

First of all, check to see that there are no interruptions in the gas and electrical supplies, and, in particular, that the gas valves for the mains are open.

## **If the burner does not light or the flame is not uniform around the burner.**

Check to make sure that:

- The gas holes on the burner are not clogged.
- All of the movable parts that make up the burner are mounted correctly.
- There are no draughts around the cooking surface.

## **If the flame does not stay lit.**

Check to make sure that:

- You press the knob all the way in.
- You keep the knob pressed in long enough to activate the flame failure device.
- The gas holes are not clogged in the area corresponding to the flame failure device.

## **If the burner does not remain on when set to "Low".**

Check to make sure that:

- The gas holes are not clogged.
- There are no draughts near the cooking surface.

## **If the cookware is not stable.**

Check to make sure that:

- The bottom of the cookware is perfectly flat.
- The cookware is centered correctly on the burner .
- The support grids have not been inverted.

## **If your oven releases a lot of smoke during cooking.**

Check to make sure that:

- You have selected the correct cooking mode for the type of food and the dish is in the correct recommended shelf position.
- The temperature is correct for the type of cooking required.
- The oven interior is clean. Food residue encrusted onto the enamel coating inside the oven becomes charred and creates both smoke and odours.
- Dish is placed onto baking tray, splashes of grease or overflows onto very hot surfaces create smoke.

If, despite all of these checks, the cooker does not function properly and problem persists, call Hotpoint Service (see KEY CONTACTS, back page), informing them of:

- The type of problem.
- The abbreviation used to identify the model (Mod. ...) as indicated on the warranty.

## **IMPORTANT:**

Never call upon technicians not authorized by the manufacturer, and refuse to accept spare parts that are not original.

# INSTALLATION

The following instructions are provided for qualified installers so that they may carry out installation, adjustment and technical maintenance operations correctly and in compliance with the applicable norms in force.

**Important: Disconnect the appliance from the electrical and gas supply before performing any maintenance or repair.** Maximum caution should be used should it be necessary to keep the appliance connected to the electricity supply.

The cooker has the following technical specifications:

- Cat. II2H3+

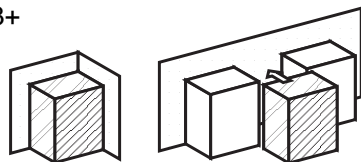

Class 1      Class 2 sub-class 1

The dimensions of the appliance are given in the figure on page 5, 'KNOW YOUR COOKER'. For trouble-free operation of appliances installed in furniture cabinets, the minimum distances shown in fig. 5 should be observed. Adjacent surfaces and the wall at the rear should also be able to withstand a temperature rise of 65 °C.

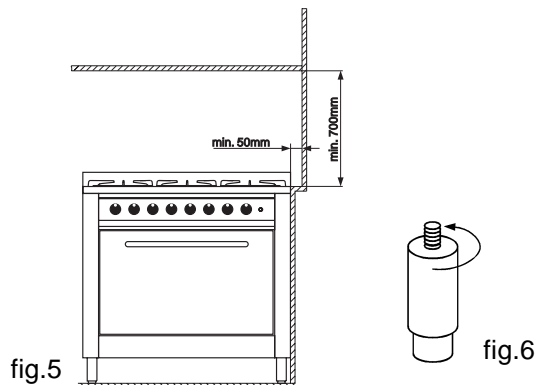

Prior to installing the cooker, the 99 - 155 mm high supporting feet (provided) should be fitted into the holes to be underneath the cooker (fig. 6). These feet are screw-adjustable and whenever necessary should be used to make sure the cooker is level.

## Positioning

Important: this unit may be installed and used only in permanently ventilated rooms according to the British Standards Codes Of Practice: B.S. 6172/B.S. 5440, Par. 2 and B.S. 6891 Current Editions. The following requirements must be observed:

- The cooker should not be installed in a bed sitting room with a volume of less than 20m<sup>3</sup>. If it is installed in a room of volume less than 5m<sup>3</sup> an air vent of effective area of 110cm<sup>2</sup> is required, if it is installed in a room of volume between 5m<sup>3</sup> and 10m<sup>3</sup> a supplementary airvent area of 50cm<sup>2</sup> is required, if the volume exceeds 11m<sup>3</sup> no airvent is required. However, if the room has a door or a window which opens directly to the outside no air vent is required even when the volume is between 5m<sup>3</sup> and 11m<sup>3</sup>.
- During prolonged use of the appliance you may consider it necessary to open a window to the outside to improve ventilation.
- If there are other fuel burning appliances in the same room, B.S.5440 Part 2 Current Edition, should, be consulted to determine the requisite air vent requirements.

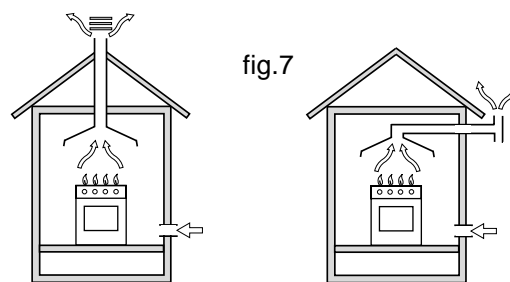

In a chimney stack or branched flue (reserved for cooking appliances)

Directly to the outside

## Kitchen ventilation

The air flow into the room where the appliance is installed must equal the quantity of air that is required for regular combustion of the gas and for ventilating the same room. Air must enter naturally through permanent apertures made in the outside walls of the room or through single or branching collective ventilation ducts in compliance with the norms. The air must be taken directly from the outside, from an area far from sources of pollution. The ventilation aperture must have the following characteristics (fig. 8A):

- total free cross section of passage of at least 6cm<sup>2</sup> for every kW of rated heating capacity of the appliance, with a minimum of 100cm<sup>2</sup> (the heating capacity is indicated on the rating plate);
- it must be made in such a way that the aperture, both on the inside and outside of the wall, cannot be obstructed;
- it must be protected, e.g. with grates, wire mesh, etc. in such a way that the above-mentioned free section is not reduced;
- it must be situated as near to floor level as possible.

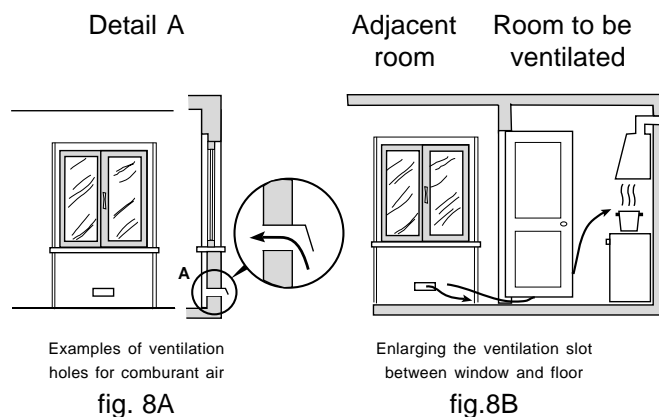

Examples of ventilation holes for comburant air

fig. 8A

Enlarging the ventilation slot between window and floor

fig.8B

The air inflow may also be obtained from an adjoining room, provided the latter is not a bedroom or a room where there is a risk of fire, such as warehouses, garages, fuel stores, etc. and is ventilated in compliance with the norms. The air flow from the adjoining room to the one to be ventilated may pass freely through permanent apertures with a cross section at least equal to that indicated above. These apertures may also be obtained by increasing the gap between the door and the floor (fig. 8B). If an electric fan is used for extracting the combustion products, the ventilation aperture must be increased in relation to its maximum performance. The electric fan should have a sufficient capacity to guarantee an hourly exchange of air equal to 3 ÷ 5 times the volume of the kitchen. Prolonged, intensive use of the appliance may require extra ventilation, e.g. an open window

# INSTALLATION

or a more efficient ventilation system by increasing the extraction power of the electric fan if installed. Liquid petroleum gas descends towards the floor as it is heavier than air. Apertures in the outside walls in rooms containing LPG cylinders should therefore be at floor level, in order to allow any gas from leaks to be expelled. Do not store LPG cylinders (even when empty) in basements or rooms below ground level; it is advisable to keep only the cylinder in use in the room at any one time and connected far from heat sources which could raise its temperature to above 50 °C.

## Gas connection for the gas hob

The hob should be connected to the gas supply by a CORGI registered installer. During installation of this product it is essential to fit an approved gas tap to isolate the supply from the appliance for the convenience of any subsequent removal or servicing. Connection of the appliance to the gas mains or liquid gas must be carried out according to the prescribed regulations in force, and only after it has been ascertained that it is adaptable to the type of gas to be used. If not, follow instructions indicated in the paragraph headed, 'Adapting to different types of gas'.

In the case of connection to liquid gas, in a cylinder, a pressure regulator, that conform to the regulations in force, must be inserted.

**Important:** for safety, for the correct regulation of gas use and long life of the appliance, ensure that the gas pressure conforms to the indications given in table 1, 'Burner and Nozzle Specifications'.

## Connection to non-flexible tube

(copper or steel)

Connection to the gas source must be done in such a way as to not create any stress points at any part of the appliance. The appliance is fitted with an adjustable, 'L' shaped connector and a gasket for the attachment to the gas supply. Should this connector have to be turned, the gasket must be replaced (supplied with the appliance).

The feeding connector of the gas to the appliance is threaded 1/2" gas male cylinder.

## Connection to flexible steel tube

The gas feed connector to the appliance is a threaded, male

1/2" connector for round gas pipe. Only use pipes and sealing gaskets that conform to the standards currently in force.

- it should be as short as possible, with a maximum length of 1.5 metres;
- it should not be bent or kinked;
- it should not be in contact with the rear panel of the appliance or in any case with parts which may reach a temperature of 50°.
- it should not pass through holes or slits used for discharging the oven flue gases;
- it should not come into contact with pointed parts or sharp corners;
- it should be easy to inspect along its entire length in order to be able to check its condition;
- it should be replaced before the date printed on the actual pipe.

## Check the seal

Upon completion of installation, check for leaks from the gas circuit using a soapy water solution (never use a flame). Make sure that the natural gas pipe is adequate for a sufficient supply to the appliance when all the burners are lit.

## Adapting to different types of gas (instructions for the hob)

To adapt the hob to a different type of gas from the factory-set one (indicated on the rating plate at the top of the hood or on the packaging), the burner nozzles should be replaced as follows:

- Remove the pan supports and slide the burners off their seats.
- Unscrew the nozzles (fig. 9, using a 7 mm socket spanner and replace them with nozzles for the new type of gas (see table 1 "Burner and nozzle specifications").
- Reassemble the parts following the above procedure in the reverse order.
- On completion of this operation, replace the old rating label with the one indicating the new type of gas used. This sticker is available from Hotpoint Service (see KEY CONTACTS, back page).

## Adjusting the primary air of the burners

The primary air of the burners does not need to be adjusted.

## Adjusting the low flame

- Turn the tap to the low flame position;
- Remove the knob and turn the adjusting screw, situated to the right of the tap (fig. 10) until you obtain a regular small flame, using a screwdriver (loosening the screw increases the height of the flame, tightening decreases it).

**N.B.:** In the case of liquid gas, the regulation screw must be screwed in all the way.

- Having obtained the low flame setting required and with the burner lit, change the position of the knob several times from minimum to maximum and vice versa and check that the flame does not go out.
- In appliances fitted with the safety device (thermocouple), should the device fail to work with the burners set to the low flame setting, increase the low flame setting of the same on the adjusting screw.

Once the adjustment has been made, remount the seals on the by-passes using leak detection fluid.

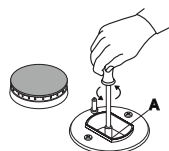

fig.9

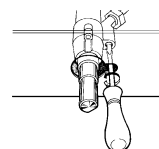

fig.10

Those ovens equipped with a three-pole power supply cable are designed to operate with an alternating current with the voltage and frequency indicated on the data plate (located on the appliance) and in the instruction booklet.

**WARNING: THIS APPLIANCE MUST BE EARTHED.**

The wire for earthing the appliance is yellow-green in colour.



The appliance should be installed by a qualified electrician in accordance with the latest edition of the IEE regulations.

**Fitting on a power supply cable**

Opening the terminal board:

- Using a screwdriver, press on the side tabs on each side of the terminal board cover.
- Pull open the cover of the terminal board.

To mount the power supply cable, proceed as follows:

- Remove the wire clamp screw and the three contact screws L-N- 
- Fasten the wires beneath the screwheads using the following colour scheme:  
**Blue (N) Brown (L) Yellow-Green **
- Secure the supply cable in place with the clamp and close the cover of the terminal board.

**Connecting the supply cable to the mains**

The appliance must be connected to a double pole isolating switch, having a minimum contact separation of 3mm.

The supply cable must be in such a position that no part of it can reach a temperature of 50°C above room temperature.

Before connecting to the power supply, make sure that:

- The electrical safety of this appliance can only be guaranteed if the cooker is correctly and efficiently earthed, in compliance with regulations on electrical safety. Always ensure that the earthing is efficient; if you have any doubts call in a qualified technician to check the system. The manufacturer denies all responsibility for damage resulting from a system which has not been earthed.
- Before plugging the appliance into the mains, check that the specifications indicated on the rating plate (on the appliance and packaging) correspond to those of the electrical and gas mains of your home.
- Check that the electrical capacity of the system and sockets will support the maximum power of the appliance, as indicated on the data plate. If in doubt, consult a qualified technical engineer.
- If the socket and appliance plug are not compatible, have the socket replaced with a suitable model by a qualified technical engineer. The latter, in particular, will also have to ensure that the cross section of the socket cables are suitable for the power absorbed by the appliance. The use of adapters, multiple sockets and/or extensions, is not recommended. If their use cannot be avoided, remember to use only single or multiple adapters and extensions which comply with current safety regulations. In these cases, never exceed the maximum current capacity indicated on the single adapter or extension and the maximum power indicated on the multiple adapter. **The plug and socket must be easily accessible.**

## BURNER AND NOZZLE SPECIFICATIONS

Table 1

BURNER	Diameter (mm)	Thermal Power kW (H.s.)*		Liquid gas				Natural gas	
		Nominal	Reduced	By-pass 1/100 (mm)	Nozzle 1/100 (mm)	Flow * g/h		Nozzle 1/100 (mm)	Flow * l/h
						G30	G31		
<b>C. Rapid</b>	100	3.00	0.7	40	86	218	214	116	286
<b>B. Semi-rapid</b>	75	1.65	0.4	30	64	120	118	96	157
<b>A. Auxiliary</b>	55	1.0	0.3	27	50	73	71	71	95
<b>D. Triple Ring</b>	130	3.25	1.3	57	91	236	232	124	309
Supply pressures	Nominal (mbar) Minimum (mbar) Maximum (mbar)					28-30	37		20
						20	25		17
						35	45		25

\* At 15°C and 1013 mbar-dry gas  
 Propane P.C.S. = 50.37 MJ/Kg  
 Butane P.C.S. = 49.47 MJ/Kg  
 Natural P.C.S. = 37.78 MJ/m<sup>3</sup>



### Disposal of old electrical appliances

The European Directive 2002/96/EC on Waste Electrical and Electronic Equipment (WEEE), requires that old household electrical appliances must not be disposed of in the normal unsorted municipal waste stream. Old appliances must be collected separately in order to optimise the recovery and recycling of the materials they contain and reduce the impact on human health and the environment. The crossed out "wheeled bin" symbol on the product reminds you of your obligation, that when you dispose of the appliance it must be separately collected.

Consumers may take their old appliance to public waste collection areas, other communal collection areas, or if national legislation allows return it to a retailer when purchasing a similar new product.

All major household appliance manufacturers are active in the creation of systems to manage the collection and disposal of old appliances.



**This appliance conforms to the following European Economic Community directives:**

- 73/23/EEC of 19/02/73 (Low Voltage) and subsequent modifications;
- 89/336/EEC of 03/05/89 (Electromagnetic Compatibility) and subsequent modifications;
- 90/336/EEC of 29/06/90 (Gas) and subsequent modifications;
- 93/68/EEC of 22/07/93 and subsequent modifications.

## OVEN SPECIFICATIONS

**Inner Volume of the ELECTRIC Oven:**

**68 litres**

**Voltage and Frequency of Power Supply:**

**230V ~ 50Hz 2800W**





## After Sales Service

No one is better placed to care for your Hotpoint appliance during the course of its working life than us - the manufacturer.

## Essential Contact Information

### Hotpoint Service

We are the largest service team in Europe offering you access to 400 skilled telephone advisors and 1100 fully qualified engineers on call to ensure you receive fast, reliable, local service.

**UK: 08709 066 066**

**Republic of Ireland: 0818 313 413**

**[www.hotpointservice.co.uk](http://www.hotpointservice.co.uk)**

**Please note: Our advisors will require the following information:**

**Model number:**

**Serial number:**

### Parts and Accessories

We supply a full range of genuine replacement parts as well as accessory products that protect and hygienically clean your appliance to keep it looking good and functioning efficiently throughout its life.

**UK: 08709 077 077**

**Republic of Ireland: 0818 313 413**

**[www.hotpointservice.co.uk](http://www.hotpointservice.co.uk)**

### Appliance Registration

We want to give you additional benefits of Hotpoint ownership. To activate your free 5 year parts guarantee you must register your appliance with us.

**UK: 0870 6092094**

**Republic of Ireland: 01 230 0800**

**[www.hotpointservice.co.uk](http://www.hotpointservice.co.uk)**

**Indesit Company UK Ltd. Morley Way, Peterborough, PE2 9JB**

Indesit Company Unit 49 Airways Industrial Estate, Dublin 17



## Recycling & Disposal Information

As part of Hotpoint's continued commitment to helping the environment, Hotpoint reserves the right to use quality, recycled components to keep down customer costs and minimise material wastage.

Please dispose of packaging and old appliances carefully. To minimise the risk of injury to children, remove the door, plug and cut the mains cable off flush with the appliance. Dispose of these parts separately to ensure that the appliance can no longer be plugged into a mains socket, and the door cannot be locked shut.



## Guarantee

### 12 Months Parts and Labour Guarantee

Your appliance has the benefit of our manufacturer's guarantee, which covers the cost of breakdown repairs for twelve months from the date of purchase.

This gives you the reassurance that if, within that time, your appliance is proven to be defective because of either workmanship or materials, we will, at our discretion, either repair or replace the appliance at no cost to you.

This guarantee is subject to the following conditions:

- The appliance has been installed and operated correctly and in accordance with our operating and maintenance instructions.
- The appliance is used only on the electricity or gas supply printed on the rating plate.
- The appliance has been used for normal domestic purposes only.
- The appliance has not been altered, serviced, maintained, dismantled, or otherwise interfered with by any person not authorised by us.
- Any repair work must be undertaken by us or our appointed agent.
- Any parts removed during repair work or any appliance that is replaced become our property.
- The appliance is used in the United Kingdom or Republic of Ireland.

The guarantee **does not cover**:

- Damage resulting from transportation, improper use, neglect or interference or as a result of improper installation.
- Replacement of any consumable item or accessory . These include but are not limited to: plugs, cables, batteries, light bulbs, fluorescent tubes and starters, covers and filters.
- Replacement of any removable parts made of glass or plastic.

**THIS GUARANTEE WILL NOT APPLY IF THE APPLIANCE HAS BEEN USED IN COMMERCIAL OR NON-DOMESTIC PREMISES.**

### 5 Year Parts Guarantee

Hotpoint also offers you a free 5 year parts guarantee. This additional guarantee is conditional on you registering your appliance with us and the parts being fitted by one of our authorised engineers. There will be a charge for our engineer's time. To activate the extra parts warranty on your appliance, simply call our registration line on **0870 6092094 (ROI 01 230 0800)**.

### Extended Guarantees

We offer a selection of repair protection plans that enable you to fully cover yourself against the expense of repair bills for the life of your policy. To find the ideal plan for you please call our advice line on **08709 088 088 (ROI 01 230 0233)**.

### Free Helpdesk Service

We have a dedicated team who can provide free advice and assistance with your appliance if you experience any technical difficulties within the first 90 days of ownership. Simply call our Hotpoint Service Hotline on **08709 066 066 (ROI 0818 313 413)** for telephone assistance, or, where necessary, to arrange for an engineer to call. If we cannot resolve the technical problem we will replace your machine or, if you prefer, give you your money back.



## Key Contacts

### After Sales Service

Over 1200 trained specialists, directly employed by us, ensure that you can have complete confidence in both the appliances and services we offer.

#### Repair Service and Information Desk

UK: 08709 066 066

(Open 8 to 8 Mon - Fri, 8.30 to 5.30 Sat, 10 to 4 Sun & Bank Holidays)

[www.hotpointservice.co.uk](http://www.hotpointservice.co.uk)

Republic of Ireland: 1850 302 200

Note: Our operators will require the following information:

Model number:

Serial number:

#### Extended Warranties

UK: 08709 088 088

(Open 8 to 8 Mon - Sun)

[www.hotpointservice.co.uk](http://www.hotpointservice.co.uk)

Republic of Ireland: 1850 502 200

#### Genuine Parts and Accessories

UK: 08709 077 077

(Open 8-30 to 5-30 Mon - Fri & 9 to 12 Sat)

[www.hotpointservice.co.uk](http://www.hotpointservice.co.uk)

Republic of Ireland: (01) 842 6836

Merloni Elettrodomestici UK Ltd, Morley Way, Peterborough, PE2 9JB.